



**Extron Electronics**

1025 E. BALL ROAD  
ANAHEIM, CA 92805

**COLLEGE OF MARIN**

835 COLLEGE AVE.  
KENTFIELD, CA 94904-2590

THE INFORMATION AND/OR ILLUSTRATION ARE THE EXCLUSIVE PROPERTY OF EXTRON ELECTRONICS. NO DUPLICATION OR REPRODUCTION IS ALLOWED WITHOUT THE EXPRESS WRITTEN PERMISSION OF EXTRON ELECTRONICS.

**COLLEGE OF MARIN**  
PROJECT NAME: CAMPUS STANDARDS

<u>SHEET</u>	<u>DESCRIPTION</u>	<u>DRAWING NUMBER</u>
1	COVER PAGE	2799059
2	DUAL DISPLAY CLASSROOM	2799059
3	SINGLE DISPLAY CLASSROOM	2799059
4	STANDARD CONFERENCE ROOMS	2799059
5	ACTIVE LEARNING SPACE	2799059
6	LARGE ACTIVITY SPACE	2799059

REVISIONS:	DATE:
△ REVISED PER CUSTOMER COMMENTS	08/21/18
△ REVISED PER CUSTOMER COMMENTS	09/10/18
△ REVISED PER CUSTOMER COMMENTS	10/08/18
△ REVISED PER CUSTOMER COMMENTS	01/21/19
△ REVISED PER CUSTOMER COMMENTS	04/15/19
△	
△	

DESCRIPTION:

COVER PAGE

APPROVED BY:

JAMES CAMARILLO

REQUESTED BY:

PATRICK EKOUE-TOTOU

DRAWN BY:

STANLEY MENCHAVEZ

CALL LOG No.:	DATE:
2799059	08/01/18

SHEET:	SCALE:
1 OF 6	NTS



Extron Electronics

1025 E. BALL ROAD  
ANAHEIM, CA 92805

COLLEGE OF MARIN

835 COLLEGE AVE.  
KENTFIELD, CA 94904-2590

THE INFORMATION AND/OR ILLUSTRATION ARE THE EXCLUSIVE PROPERTY OF EXTRON ELECTRONICS. NO DUPLICATION OR REPRODUCTION IS ALLOWED WITHOUT THE EXPRESS WRITTEN PERMISSION OF EXTRON ELECTRONICS.

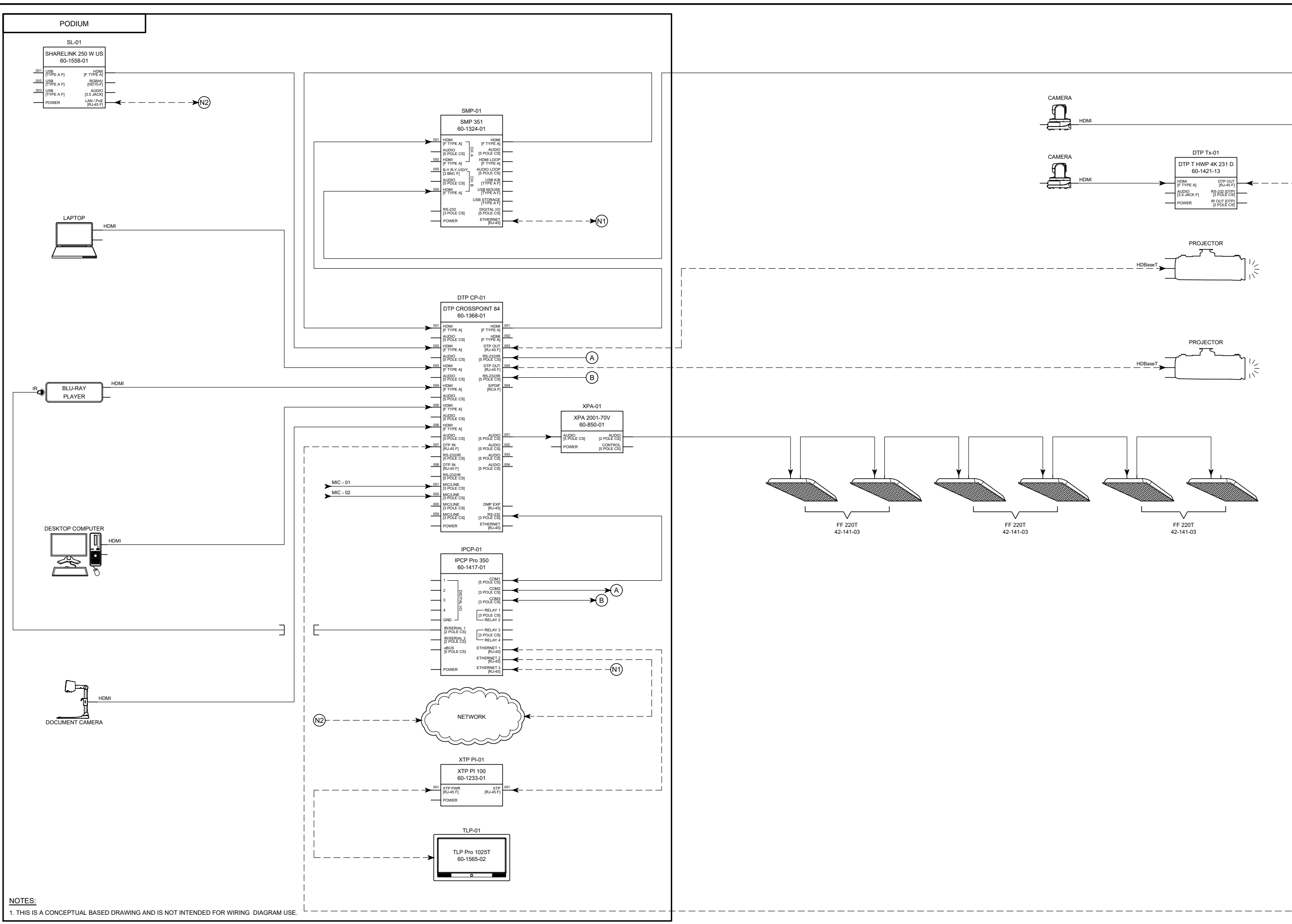

NOTES:  
1. THIS IS A CONCEPTUAL BASED DRAWING AND IS NOT INTENDED FOR WIRING DIAGRAM USE.

REVISIONS:	DATE:
NO CHANGES MADE ON THIS SHEET	08/21/18
NO CHANGES MADE ON THIS SHEET	09/10/18
REVISED PER CUSTOMER COMMENTS	10/08/18
REVISED PER CUSTOMER COMMENTS	01/21/19
NO CHANGES MADE ON THIS SHEET	04/15/19

DESCRIPTION:  
DUAL DISPLAY CLASSROOM

APPROVED BY:  
JAMES CAMARILLO

REQUESTED BY:  
PATRICK EKOUE-TOTOU

DRAWN BY:  
STANLEY MENCHAVEZ

CALL LOG No.: 2799059 DATE: 08/01/18

SHEET: 2 OF 6 SCALE: NTS



**Extron Electronics**  
 1025 E. BALL ROAD  
 ANAHEIM, CA 92805

**COLLEGE OF MARIN**  
 835 COLLEGE AVE.  
 KENTFIELD, CA 94904-2590

THE INFORMATION AND/OR ILLUSTRATION ARE THE EXCLUSIVE PROPERTY OF EXTRON ELECTRONICS. NO DUPLICATION NOR REPRODUCTION IS ALLOWED WITHOUT THE EXPRESS WRITTEN PERMISSION OF EXTRON ELECTRONICS.

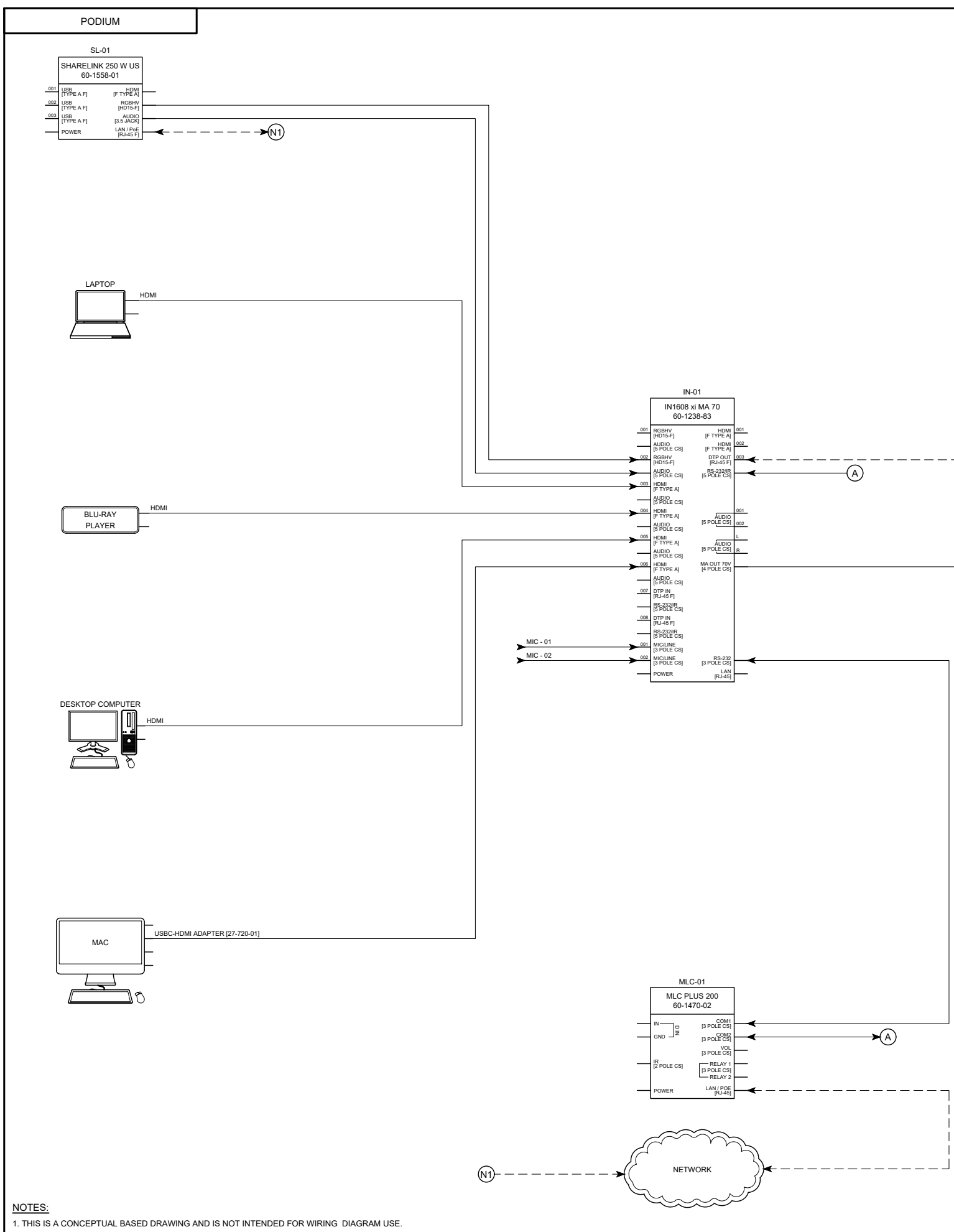

**NOTES:**  
 1. THIS IS A CONCEPTUAL BASED DRAWING AND IS NOT INTENDED FOR WIRING DIAGRAM USE.

REVISIONS:	DATE:
△ NO CHANGES MADE ON THIS SHEET	08/21/18
△ NO CHANGES MADE ON THIS SHEET	09/10/18
△ REVISED PER CUSTOMER COMMENTS	10/08/18
△ REVISED PER CUSTOMER COMMENTS	01/21/19
△ NO CHANGES MADE ON THIS SHEET	04/15/19
△	
△	

**DESCRIPTION:**  
 SINGLE DISPLAY CLASSROOM

**APPROVED BY:**  
 JAMES CAMARILLO

**REQUESTED BY:**  
 PATRICK EKOUE-TOTOU

**DRAWN BY:**  
 STANLEY MENCHAVEZ

**CALL LOG No.:** 2799059  
**DATE:** 08/01/18

**SHEET:** 3 OF 6  
**SCALE:** NTS



**Extron Electronics**  
 1025 E. BALL ROAD  
 ANAHEIM, CA 92805

**COLLEGE OF MARIN**  
 835 COLLEGE AVE.  
 KENTFIELD, CA 94904-2590

THE INFORMATION AND/OR ILLUSTRATION ARE THE EXCLUSIVE PROPERTY OF EXTRON ELECTRONICS. NO DUPLICATION NOR REPRODUCTION IS ALLOWED WITHOUT THE EXPRESS WRITTEN PERMISSION OF EXTRON ELECTRONICS.

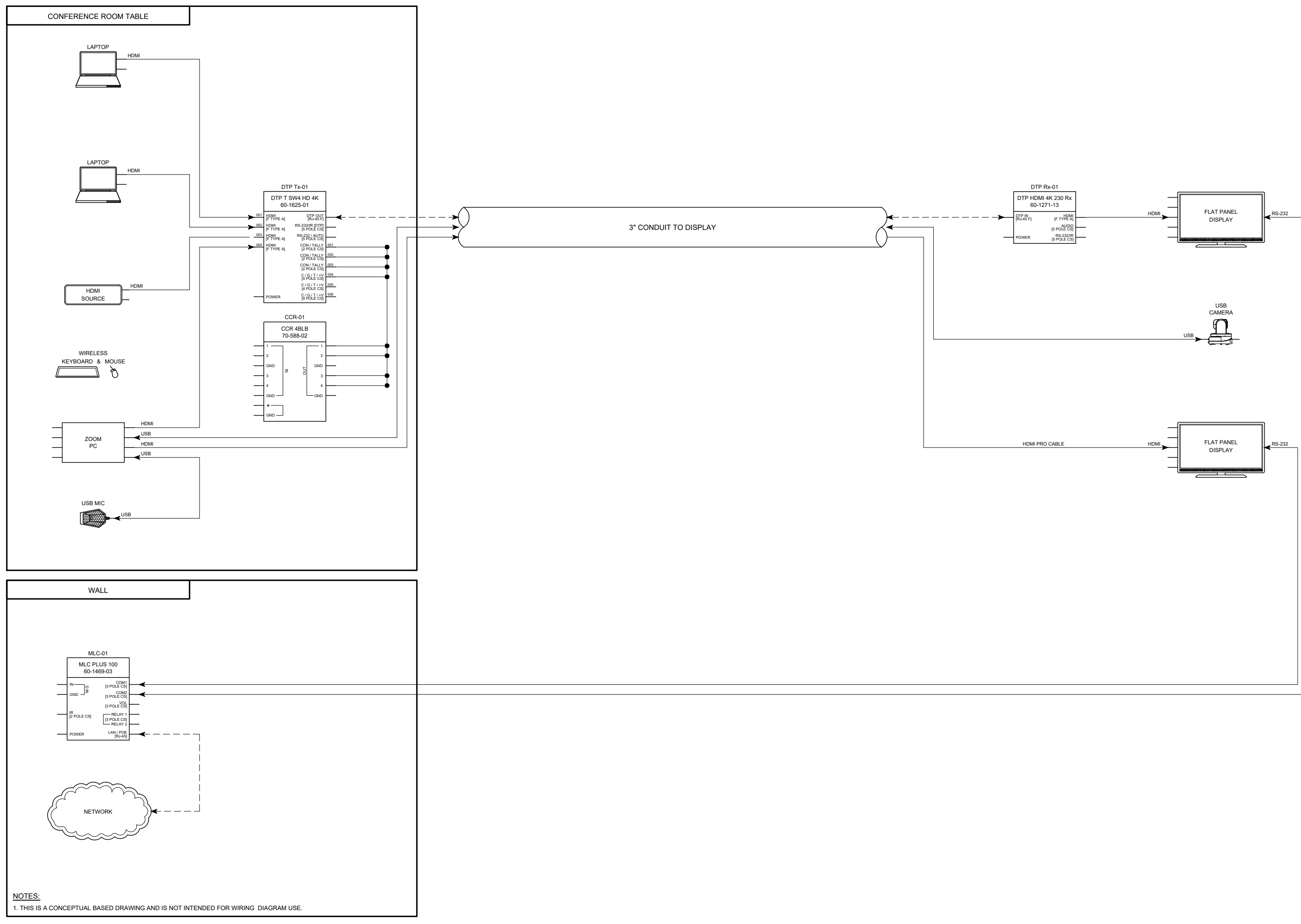

**NOTES:**  
 1. THIS IS A CONCEPTUAL BASED DRAWING AND IS NOT INTENDED FOR WIRING DIAGRAM USE.

REVISIONS:	DATE:
NO CHANGES MADE ON THIS SHEET	08/21/18
NO CHANGES MADE ON THIS SHEET	09/10/18
REVISED PER CUSTOMER COMMENTS	10/08/18
REVISED PER CUSTOMER COMMENTS	01/21/19
REVISED PER CUSTOMER COMMENTS	04/15/19

**DESCRIPTION:**  
 STANDARD CONFERENCE ROOMS

**APPROVED BY:**  
 JAMES CAMARILLO

**REQUESTED BY:**  
 PATRICK EKOUE-TOTOU

**DRAWN BY:**  
 STANLEY MENCHAVEZ

**CALL LOG No.:** 2799059  
**DATE:** 08/01/18

**SHEET:** 4 OF 6  
**SCALE:** NTS

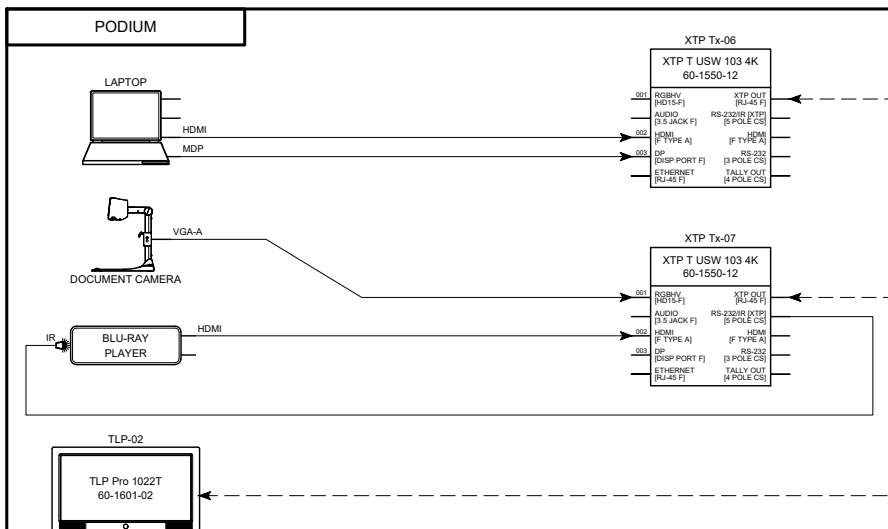
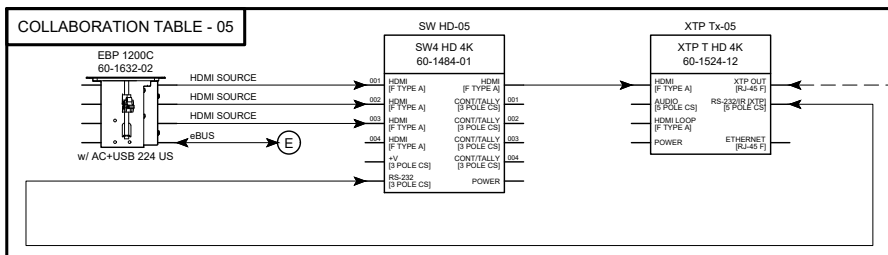
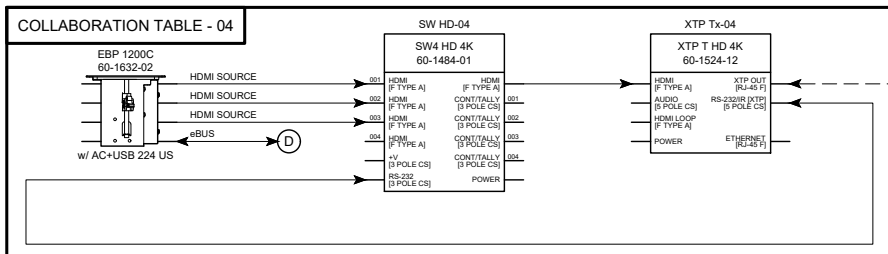
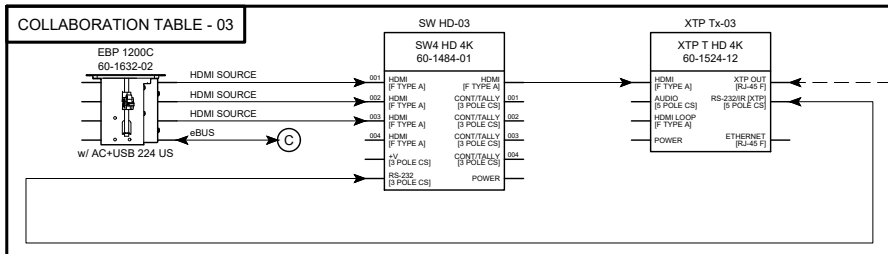
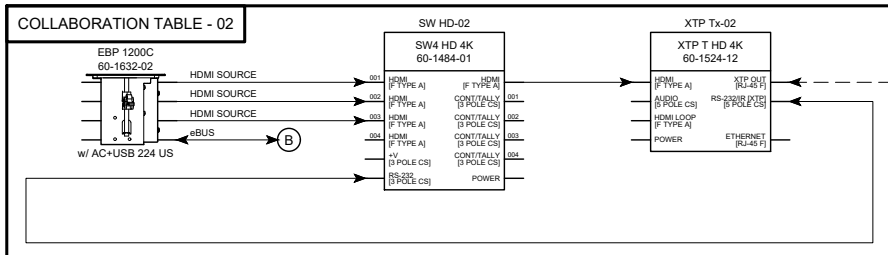
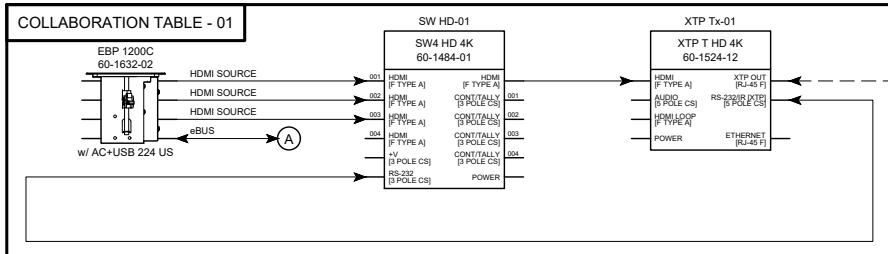

**NOTES:**  
 1. THIS IS A CONCEPTUAL BASED DRAWING AND IS NOT INTENDED FOR WIRING DIAGRAM USE.

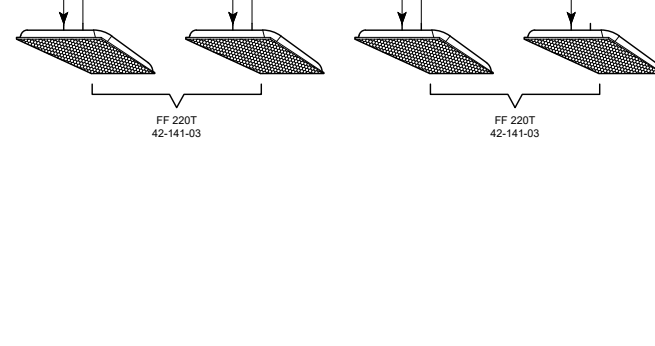
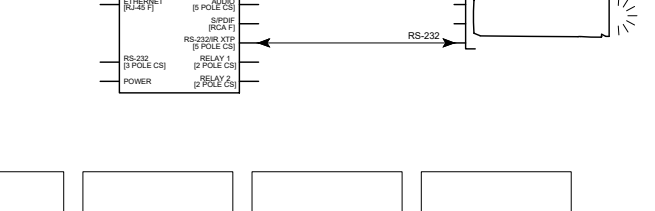
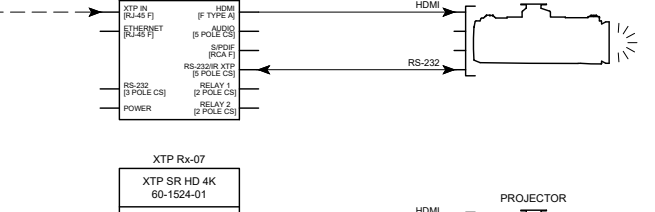
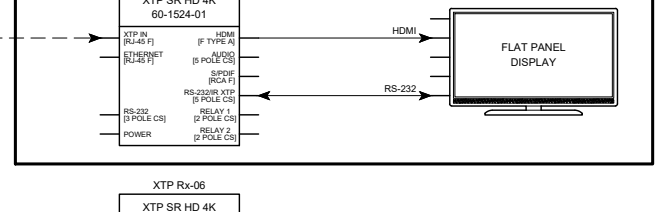
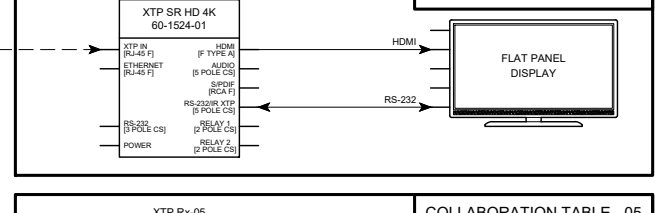
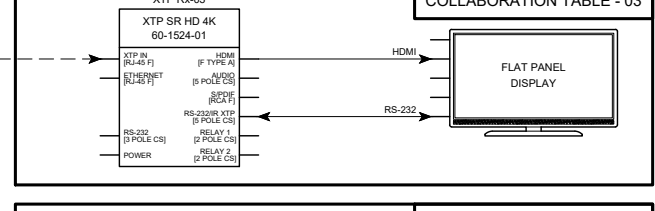
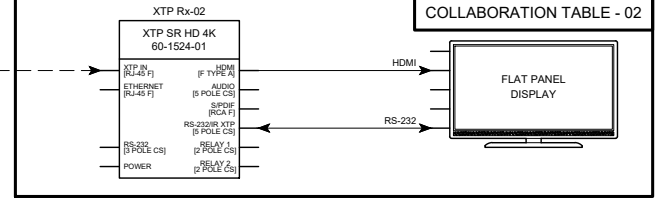
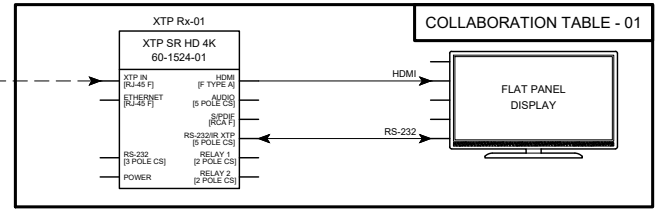
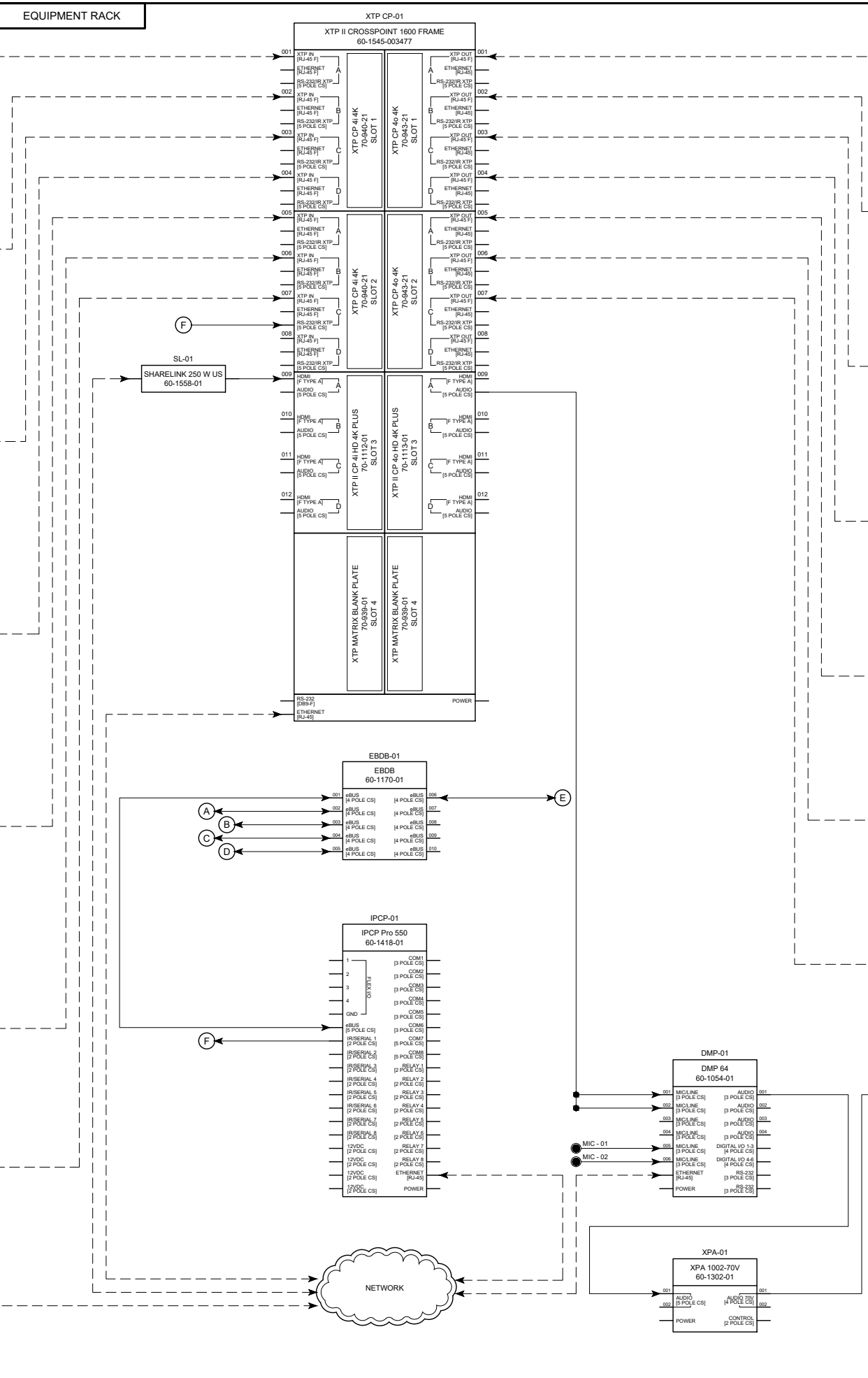

**Extron Electronics**  
 1025 E. BALL ROAD  
 ANAHEIM, CA 92805

**COLLEGE OF MARIN**  
 835 COLLEGE AVE.  
 KENTFIELD, CA 94904-2590

REVISIONS:	DATE:
▲ REVISED PER CUSTOMER COMMENTS	08/21/18
▲ NO CHANGES MADE ON THIS SHEET	09/10/18
▲ REVISED PER CUSTOMER COMMENTS	10/08/18
▲ REVISED PER CUSTOMER COMMENTS	01/21/19
▲ NO CHANGES MADE ON THIS SHEET	04/15/19

**DESCRIPTION:**  
 ACTIVE LEARNING SPACE

**APPROVED BY:**  
 JAMES CAMARILLO

**REQUESTED BY:**  
 PATRICK EKOUE-TOTOU

**DRAWN BY:**  
 STANLEY MENCHAVEZ

**CALL LOG No.:** 2799059  
**DATE:** 08/01/18

**SHEET:** 5 OF 6  
**SCALE:** NTS

THE INFORMATION AND/OR ILLUSTRATION ARE THE EXCLUSIVE PROPERTY OF EXTRON ELECTRONICS. NO DUPLICATION OR REPRODUCTION IS ALLOWED WITHOUT THE EXPRESS WRITTEN PERMISSION OF EXTRON ELECTRONICS.

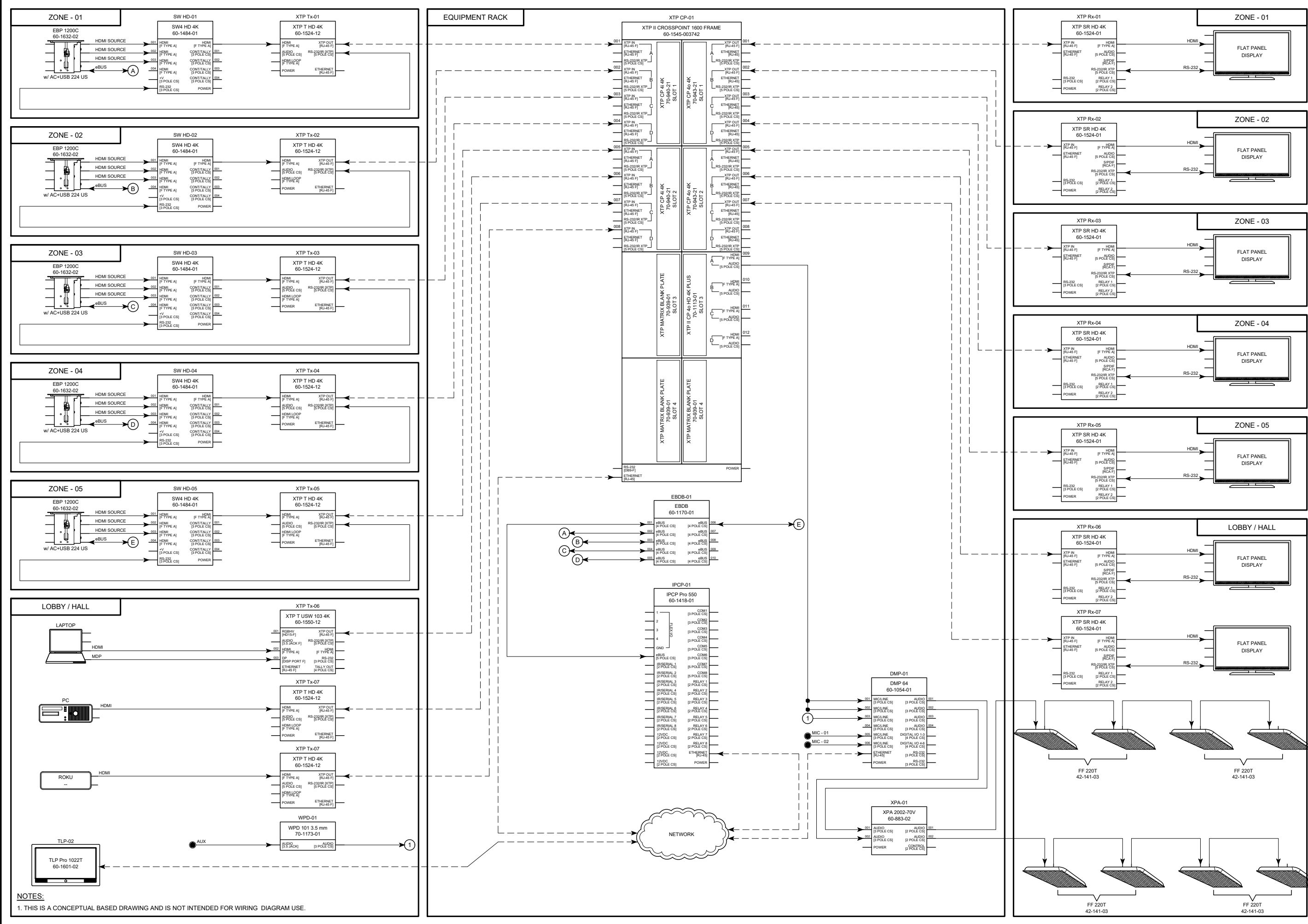

NOTES:  
 1. THIS IS A CONCEPTUAL BASED DRAWING AND IS NOT INTENDED FOR WIRING DIAGRAM USE.



**Extron Electronics**  
 1025 E. BALL ROAD  
 ANAHEIM, CA 92805

**COLLEGE OF MARIN**  
 835 COLLEGE AVE.  
 KENTFIELD, CA 94904-2590

THE INFORMATION AND/OR ILLUSTRATION ARE THE EXCLUSIVE PROPERTY OF EXTRON ELECTRONICS. NO DUPLICATION OR REPRODUCTION IS ALLOWED WITHOUT THE EXPRESS WRITTEN PERMISSION OF EXTRON ELECTRONICS.

REVISIONS:	DATE:
△ ADDED THIS SHEET TO SET	09/10/18
△ REVISED PER CUSTOMER COMMENTS	10/08/18
△ REVISED PER CUSTOMER COMMENTS	01/21/19
△ REVISED PER CUSTOMER COMMENTS	04/15/19

DESCRIPTION:  
 LARGE ACTIVITY SPACE

APPROVED BY:  
 JAMES CAMARILLO

REQUESTED BY:  
 PATRICK EKOUE-TOTOU

DRAWN BY:  
 STANLEY MENCHAVEZ

CALL LOG No.: 2799059 DATE: 09/10/18

SHEET: 6 OF 6 SCALE: NTS